

Customizable Fail-Safe modulating actuator for controlling dampers in typical commercial HVAC applications.

- Torque motor 270 in-lb [30 Nm]
- Nominal voltage AC/DC 24 V
- Control Modulating
- Position feedback 2...10 V
- 2x SPDT
- NEMA 4



5-year warranty



Technical data

Electrical data	Nominal voltage	AC/DC 24 V
	Nominal voltage frequency	50/60 Hz
	Nominal voltage range	AC 19.2...28.8 V / DC 21.6...28.8 V
	Power consumption in operation	8 W
	Power consumption in rest position	4.5 W
	Transformer sizing	14 VA
	Auxiliary switch	2x SPDT, 1 mA...3 A (0.5 A inductive), DC 5 V...AC 250 V, one set at 10°, one set at 85°
	Switching capacity auxiliary switch	1 mA...3 A (0.5 A inductive), DC 5 V...AC 250 V
	Electrical Connection	Terminal block(s) inside junction box with knockouts
	Overload Protection	electronic throughout 0...95° rotation
Electrical Protection	actuators are double insulated	
Functional data	Torque motor	270 in-lb [30 Nm]
	Operating range Y	2...10 V
	Operating range Y note	4...20 mA w/ ZG-R01 (500 Ω, 1/4 W resistor)
	Input impedance	100 kΩ for 2...10 V (0.1 mA), 500 Ω for 4...20 mA
	Position feedback U	2...10 V
	Position feedback U note	Max. 0.5 mA
	Direction of motion motor	selectable with switch 0/1
	Direction of motion fail-safe	reversible with cw/ccw mounting
	Manual override	5 mm hex crank (3/16" Allen), supplied
	Angle of rotation	Max. 95°
	Angle of rotation note	adjustable with mechanical end stop, 35...95°
	Running Time (Motor)	95 s / 90°
	Running time fail-safe	<20 s @ -4...122°F [-20...50°C], <60 s @ -22°F [-30°C]
	Adaptation Setting Range	manual, by two full cycles of 0/1 switch
	Noise level, motor	56 dB(A)
Noise level, fail-safe	71 dB(A)	
Position indication	Mechanical	
Safety data	Power source UL	Class 2 Supply
	Degree of protection IEC/EN	IP66
	Degree of protection NEMA/UL	NEMA 4
	Enclosure	UL Enclosure Type 4
	Agency Listing	cULus acc. to UL60730-1A/-2-14, CAN/CSA E60730-1:02, CE acc. to 2014/30/EU and 2014/35/EU
	Quality Standard	ISO 9001
	Ambient humidity	Max. 100% RH

Safety data	Ambient temperature	-22...122°F [-30...50°C]
	Ambient temperature note	-40...50°C for actuator with integrated heating
	Storage temperature	-40...176°F [-40...80°C]
	Servicing	maintenance-free
Weight	Weight	10 lb [4.7 kg]
Materials	Housing material	Die cast aluminium and plastic casing
Footnotes	†Rated Impulse Voltage 800V, Type of action 1.AA.B, Control Pollution Degree 4.	

Product features

- Application** For fail-safe, modulating control of dampers in HVAC systems. Actuator sizing should be done in accordance with the damper manufacturer's specifications. The actuator is mounted directly to a damper shaft up to 1.05" in diameter by means of its universal clamp. A crank arm and several mounting brackets are available for applications where the actuator cannot be direct coupled to the damper shaft. The actuator operates in response to a DC 2...10 V, with the addition of a 500Ω resistor, a 4...20 mA control input from an electronic controller or positioner. A DC 2...10 V feedback signal is provided for position indication.
- A common installation technique for control of multi-section dampers is to use the U5 position feedback of one actuator (Primary) to control multiple actuators (Secondary). Belimo refers to this as primary and secondary control. The only requirement is that the actuators are installed on MECHANICALLY SEPARATE damper shafts.
- Operation** The EF..24-SR-S N4 series actuators provide true spring return operation for reliable failsafe application and positive close off on air tight dampers. The spring return system provides constant torque to the damper with, and without, power applied to the actuator. The EF..24-SR-S N4 series provides 95° of rotation and is provided with a graduated position indicator showing 0° to 95°. The EF..24-SR-S N4 uses a brushless DC motor which is controlled by an Application Specific Integrated Circuit (ASIC) and a microprocessor. The microprocessor provides the intelligence to the ASIC to provide a constant rotation rate and to know the actuator's exact fail-safe position. The ASIC monitors and controls the brushless DC motor's rotation and provides a digital rotation sensing function to prevent damage to the actuator in a stall condition. The actuator may be stalled anywhere in its normal rotation without the need of mechanical end switches. The EF..24-SR-S N4 versions are provided with two built-in auxiliary switches. These SPDT switches provide safety interfacing or signaling, for example, for fan start-up. The switching function at the fail-safe position is fixed at 10°, the other switch function is fixed at 85°. The EF..24-SR-S N4 actuator is shipped at 5° (5° from full fail-safe) to provide automatic compression against damper gaskets for tight shut-off.
- Installation Note: Use 60°C/75°C copper (CU) conductor and wire size range 12-26 AWG, stranded or solid. If conduit is used, use flexible metal conduit; UL listed and CSA certified strain relief or conduit fitting suitable for outdoor applications, rated NEMA type 4, 4X, 6 or 6X or watertight.
- Typical specification** Spring return control damper actuators shall be direct coupled type which require no crank arm and linkage and be capable of direct mounting to a jackshaft up to a 1.05" diameter. The actuator must provide modulating damper control in response to a 2 to 10 VDC or, with the addition of a 500Ω resistor, a 4 to 20 mA control input from an electronic controller or positioner. The actuators must be designed so that they may be used for either clockwise or counter clockwise fail-safe operation. Actuators shall use a brushless DC motor controlled by a microprocessor and be protected from overload at all angles of rotation. Run time shall be constant, and independent of torque. A 2 to 10 VDC feedback signal shall be provided for position feedback. Actuators with auxiliary switches must be constructed to meet the requirements for Double Insulation so an electrical ground is not required to meet agency listings. Actuators shall be cULus listed and have a 5 year warranty, and be manufactured under ISO 9001 International Quality Control Standards. Actuators shall be as manufactured by Belimo.

Adaptation and synchronisation









An adaption can be triggered by manually rotating the direction of rotation switch TWO full cycles. Adaption will detect the applications mechanical end stops by driving to each stop. An adaption will scale the control signal input, position feedback voltage, and running time to the new working mechanical angle of rotation. It is good practice to initiate an adaption on each actuator when mounting and controlling EF..-SR.. actuators in Piggy-back mode.

If the manual override is used, with power applied, the actuator will perform a Synchronization upon release of the manual override hand crank. The actuator drives from the current control position to the synchronize reference of 0%. The actuator then drives back to the control position defined by the input signal.

Accessories

Electrical accessories	Description	Type
	DC Voltage Input Rescaling Module	IRM-100
	Auxiliary switch, mercury-free	P475
	Auxiliary switch, mercury-free	P475-1
	Signal simulator, Power supply AC 120 V	PS-100
	Convert Pulse Width Modulated Signal to a 2...10 V Signal for Belimo Proportional Actuators	PTA-250
	Positioner for wall mounting	SGA24
	Positioner for front-panel mounting	SGF24
	Resistor, 500 Ω, 1/4" wire resistor with 6" pigtail wires	ZG-R01
	Resistor kit, 50% voltage divider	ZG-R02
	Transformer, AC 120 V to AC 24 V, 40 VA	ZG-X40
Mechanical accessories	Description	Type
	Shaft extension 240 mm ø20 mm for damper shaft ø8...22.7 mm	AV8-25
	Anti-rotation bracket EFB(X)/GKB(X)/GMB(X).	EF-P
	End stop indicator	IND-EFB
	Shaft clamp reversible, clamping range ø12...26.7 mm	K9-2
	Ball joint suitable for damper crank arm KH8 / KH10	KG10A
	Damper crank arm Slot width 8.2 mm, clamping range ø14...25 mm	KH10
	Actuator arm Slot width 8.2 mm	KH-EFB
	Push rod for KG10A ball joint 36" L, 3/8" diameter	SH10
	Wrench 0.512 in. [13 mm]	TOOL-07
	Mounting bracket for AF..	ZG-100
	Jackshaft mounting bracket.	ZG-120
	Damper clip for damper blade, 3.5" width.	ZG-DC1
	Damper clip for damper blade, 6" width.	ZG-DC2
	Mounting kit for linkage operation for flat and side installation	ZG-EFB
	1.05" diameter jackshaft adaptor (12" L).	ZG-JSA-3

Electrical installation

-  **Warning! Live electrical components!**
During installation, testing, servicing and troubleshooting of this product, it may be necessary to work with live electrical components. Have a qualified licensed electrician or other individual who has been properly trained in handling live electrical components perform these tasks. Failure to follow all electrical safety precautions when exposed to live electrical components could result in death or serious injury.
-  Meets cULus requirements without the need of an electrical ground connection.
-  Apply only AC line voltage or only UL-Class 2 voltage to the terminals of auxiliary switches. Mixed or combined operation of line voltage/safety extra low voltage is not allowed.
-  Provide overload protection and disconnect as required.
-  Actuators may also be powered by DC 24 V.
-  Two built-in auxiliary switches (2x SPDT), for end position indication, interlock control, fan startup, etc.
-  Only connect common to negative (-) leg of control circuits.
-  Actuators may be connected in parallel if not mechanically linked. Power consumption and input impedance must be observed.
-  Actuators are provided with a numbered screw terminal strip instead of a cable.

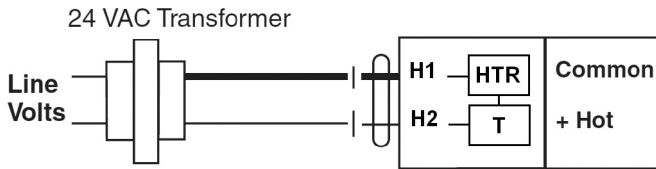

NEMA 4 Heater Option

Wiring diagrams

2...10 V / 4...20 mA Control

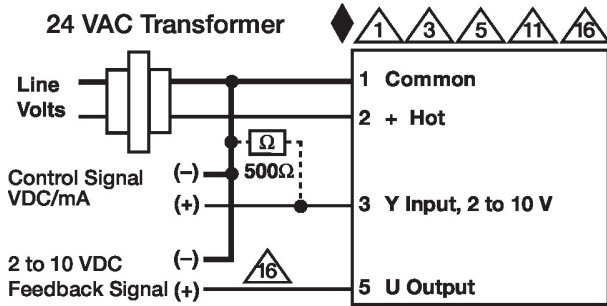

Auxiliary Switches

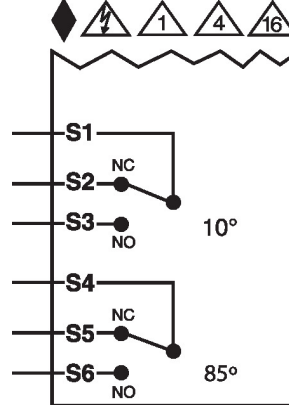

NEMA 4 Heater Option

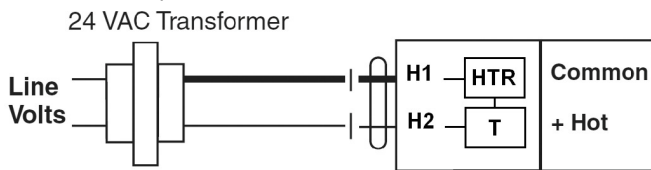

Dimensions

