

Basic Fail-Safe actuator for controlling dampers in typical commercial HVAC applications.

- Torque motor 22 in-lb [2.5 Nm]
- Nominal voltage AC/DC 24 V
- Control On/Off, Floating point



5-year warranty



Technical data

Electrical data	Nominal voltage	AC/DC 24 V
	Nominal voltage frequency	50/60 Hz
	Nominal voltage range	AC 19.2...28.8 V / DC 21.6...28.8 V
	Power consumption in operation	2.5 W
	Power consumption in rest position	1 W
	Transformer sizing	4 VA
	Electrical Connection	18 GA plenum cable, 1 m, with 1/2" conduit connector
	Overload Protection	electronic throughout 0...95° rotation
	Electrical Protection	actuators are double insulated
Functional data	Torque motor	22 in-lb [2.5 Nm]
	Direction of motion motor	selectable with switch 0/1
	Direction of motion fail-safe	reversible with cw/ccw mounting
	Angle of rotation	Max. 95°
	Angle of rotation note	adjustable with mechanical stop
	Running Time (Motor)	95 s /
	Running time motor note	constant, independent of load
	Running time fail-safe	<25 s @ -4...122°F [-20...50°C], <60 s @ -22°F [-30°C]
	Noise level, motor	35 dB(A)
Noise level, fail-safe	62 dB(A)	
Position indication	Mechanical	
Safety data	Power source UL	Class 2 Supply
	Degree of protection IEC/EN	IP42
	Degree of protection NEMA/UL	NEMA 2
	Enclosure	UL Enclosure Type 2
	Agency Listing	cULus acc. to UL60730-1A/-2-14, CAN/CSA E60730-1:02, CE acc. to 2014/30/EU
	Quality Standard	ISO 9001
	UL 2043 Compliant	Suitable for use in air plenums per Section 300.22(C) of the NEC and Section 602 of the IMC
	Ambient humidity	Max. 95% RH, non-condensing
	Ambient temperature	-22...122°F [-30...50°C]
	Storage temperature	-40...176°F [-40...80°C]
	Servicing	maintenance-free
Weight	Weight	1.6 lb [0.71 kg]
Materials	Housing material	UL94-5VA

Footnotes †Rated Impulse Voltage 800V, Type of action 1.AA, Control Pollution Degree 3

Product features

Application For modulation or On/Off, fail-safe control of dampers in HVAC systems. Actuator sizing should be done in accordance with the damper manufacturer’s specifications. The actuator is mounted directly to a damper shaft from 1/4” up to 1/2” in diameter by means of its universal clamp, 1/2” shaft centered at delivery. A crank arm and several mounting brackets are available for applications where the actuator cannot be direct coupled to the damper shaft. Control is floating point from a triac or relay, or On/Off from an auxiliary contact on a fan motor contactor, controller or manual switch.

Operation The TF series actuators provide true spring return operation for reliable fail-safe application and positive close-off on air tight dampers. The spring return system provides consistent torque to the damper with, and without, power applied to the actuator. The TF series provides 95° of rotation and is provided with a graduated position indicator showing 0 to 95°. The TF uses a brushless DC motor which is controlled by an Application Specific Integrated Circuit (ASIC) and a microprocessor. The microprocessor provides the intelligence to the ASIC to provide a constant rotation rate and to know the actuator’s exact fail-safe position. The ASIC monitors and controls the brushless DC motor’s rotation and provides a digital rotation sensing function to prevent damage to the actuator in a stall condition. The actuator may be stalled anywhere in its normal rotation without the need of mechanical end switches. Power consumption is reduced in holding mode.

Safety Note: Screw a conduit fitting into the actuator’s bushing. Jacket the actuator’s input and output wiring with suitable flexible conduit. Properly terminate the conduit in a suitable junction box.

Typical specification Floating point, On/Off spring return damper actuators shall be direct coupled type which require no crank arm and linkage and be capable of direct mounting to a shaft up to a 1/2” diameter and center a 1/2” shaft. The actuators must be designed so that they may be used for either clockwise or counter clockwise fail-safe operation. Actuators shall have an external direction of rotation switch to reverse control logic. Actuators shall use a brushless DC motor and be protected from overload at all angles of rotation. If required, one SPDT auxiliary switch shall be provided having the capability of being adjustable. Actuators with auxiliary switch must be constructed to meet the requirements for Double Insulation so an electrical ground is not required to meet agency listings. Run time shall be constant and independent of torque. Actuators shall be cULus listed, have a 5 year warranty, and be manufactured under ISO 9001 International Quality Control Standards. Actuators shall be as manufactured by Belimo.

Accessories

Electrical accessories	Description	Type
	Auxiliary switch, mercury-free	P475
	Auxiliary switch, mercury-free	P475-1
	Signal simulator, Power supply AC 120 V	PS-100
	Cable conduit connector 1/2"	TF-CC US
	Transformer, AC 120 V to AC 24 V, 40 VA	ZG-X40

Mechanical accessories	Description	Type
	Shaft extension 170 mm ø10 mm for damper shaft ø6...16 mm	AV6-20
	Position indicator for TFB(X)	IND-TF
	Shaft clamp for TFB(X)	K8 US
	Ball joint suitable for damper crank arm KH8 / KH10, Multipack 10 pcs.	KG10A
	Ball joint suitable for damper crank arm KH8, Multipack 10 pcs.	KG6
	Ball joint suitable for damper crank arm KH8, Multipack 10 pcs.	KG8
	Damper crank arm Slot width 8.2 mm, for ø1.05"	KH12
	Damper crank arm Slot width 6.2 mm, clamping range ø10...18 mm	KH6
	Damper crank arm Slot width 8.2 mm, clamping range ø10...18 mm	KH8
	TFB(X) crankarm with 5/16" slot.	KH-TF US
	TFB(X) crankarm with 1/4" slot.	KH-TF-1 US
	Screw fastening kit	SB-TF
	Push rod for KG10A ball joint 36" L, 3/8" diameter	SH10
	Push rod for KG6 & KG8 ball joints (36" L, 5/16" diameter).	SH8
	Anti-rotation bracket TF/NKQ/AM/NM/LM.	TF-P
	Wrench 0.32 in and 0.39 in [8 mm and 10 mm]	TOOL-06
	Angle of rotation limiter, with end stop	ZDB-TF
	Mounting bracket for TFB(X)	ZG-113
	Damper clip for damper blade, 3.5" width.	ZG-DC1
	Damper clip for damper blade, 6" width.	ZG-DC2
	Shaft extension for 3/8" diameter shafts (4" L).	ZG-LMSA-1
	Shaft extension for 1/2" diameter shafts (5" L).	ZG-LMSA-1/2-5
	TFB(X) crankarm adaptor kit (includes ZG-113).	ZG-TF112
	TFB(X) crankarm adaptor kit (T bracket included).	ZG-TF2
	Mounting kit for TFB(X)	ZG-TF3
	Weather shield 13x8x6" [330x203x152 mm] (LxWxH)	ZS-100
	Base plate, for ZS-100	ZS-101
	Weather shield 406x213x102 mm [16x8-3/8x4"] (LxWxH)	ZS-150

Electrical installation

Warning! Live electrical components!

During installation, testing, servicing and troubleshooting of this product, it may be necessary to work with live electrical components. Have a qualified licensed electrician or other individual who has been properly trained in handling live electrical components perform these tasks. Failure to follow all electrical safety precautions when exposed to live electrical components could result in death or serious injury.

 Meets cULus requirements without the need of an electrical ground connection.

 Actuators with appliance cables are numbered.

 Provide overload protection and disconnect as required.

 Actuators may also be powered by DC 24 V.

 Actuators Hot wire must be connected to the control board common. Only connect common to neg. (-) leg of control circuits. Terminal models (-T) have no-feedback.

 Actuators may be connected in parallel if not mechanically linked. Power consumption and input impedance must be observed.

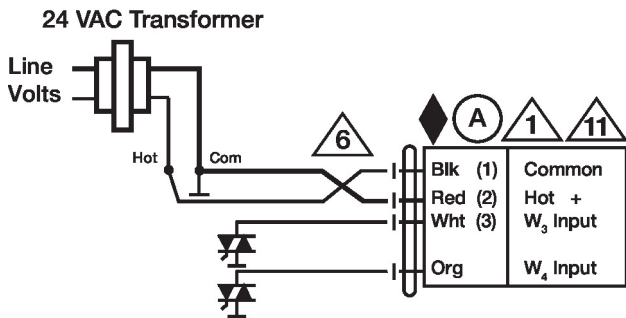

Floating Point - Triac Sink

Wiring diagrams

Floating Point

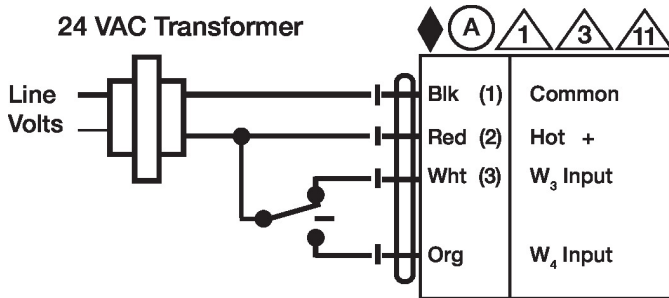

Floating Point - Triac Sink

Floating Point - Triac Source
24 VAC Transformer

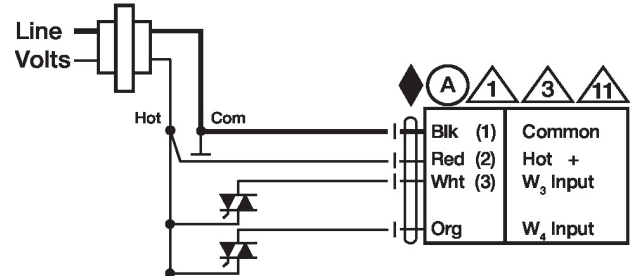

24 VAC Transformer

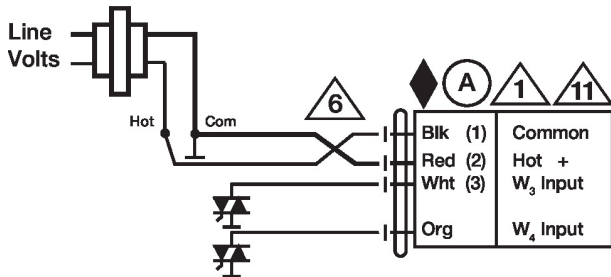

On/Off

Dimensions

