



5-year warranty



Technical data

Functional data	Valve Size	0.5" [15]
	Fluid	chilled or hot water, up to 60% glycol
	Fluid Temp Range (water)	0...250°F [-18...120°C]
	Body Pressure Rating	600 psi
	Close-off pressure Δps	200 psi
	Flow characteristic	equal percentage
	Servicing	maintenance-free
	Flow Pattern	2-way
	Leakage rate	0% for A – AB
	Controllable flow range	75°
	Cv	4.7
	Body pressure rating note	600 psi
	Cv Flow Rating	A-port: as stated in chart B-port: 70% of A – AB Cv
Materials	Valve body	Nickel-plated brass body
	Stem seal	EPDM (lubricated)
	Seat	PTFE
	Pipe connection	NPT female ends
	O-ring	EPDM (lubricated)
	Ball	stainless steel
Suitable actuators	Non-Spring	TR LRB(X) NR

Safety notes



- **WARNING:** This product can expose you to lead which is known to the State of California to cause cancer and reproductive harm. For more information go to www.p65warnings.ca.gov

Product features

Application This valve is typically used in air handling units on heating or cooling coils, and fan coil unit heating or cooling coils. Some other common applications include Unit Ventilators, VAV box re-heat coils and bypass loops. This valve is suitable for use in a hydronic system with variable flow.

Flow/Mounting details



Dimensions

Dimensional drawings



LRB, LRX

A	B	C	D	E	F	H1	H2
9.4" [239]	2.4" [60]	5.6" [141]	5.0" [127]	1.3" [33]	1.3" [33]	1.2" [30]	1.1" [28]



TR

A	B	C	D	E	F
3.7" [95]	2.4" [60]	5.2" [132]	4.6" [117]	1.3" [33]	1.3" [33]



TFRB, TFRX

A	B	C	D	E	F
7.9" [200]	2.4" [60]	6.1" [154]	5.5" [140]	1.8" [46]	1.8" [46]



LF

A	B	C	D	E	F
6.6" [167]	2.4" [60]	5.5" [139]	4.7" [120]	1.5" [39]	1.5" [39]

ARB N4, ARX N4, NRB N4, NRX N4



A	B	C	D	E	F
11.4" [289]	2.4" [60]	7.7" [196]	7.0" [179]	3.1" [80]	3.1" [80]



TFRB, TFRX

A	B	C	D	E	F
7.9" [200]	2.4" [60]	6.1" [154]	5.5" [140]	1.8" [46]	1.8" [46]



ARB N4, ARX N4, NRB N4, NRX N4

A	B	C	D	E	F
11.4" [289]	2.4" [60]	7.7" [196]	7.0" [179]	3.1" [80]	3.1" [80]



5-year warranty



Technical data

Electrical data	Nominal voltage	AC/DC 24 V
	Nominal voltage frequency	50/60 Hz
	Power consumption in operation	2.5 W
	Power consumption in rest position	1.2 W
	Transformer sizing	5 VA (class 2 power source)
	Electrical Connection	18 GA plenum cable, 3 ft [1 m], with 1/2" conduit connector
	Overload Protection	electronic throughout 0...90° rotation
Functional data	Operating range Y	2...10 V
	Operating range Y note	4...20 mA w/ ZG-R01 (500 Ω, 1/4 W resistor)
	Input Impedance	100 kΩ for DC 2...10 V (0.1 mA), 500 Ω for 4...20 mA, 1500 Ω for PWM and On/Off
	Operating range Y variable	Start point 0.5...30 V End point 2.5...32 V
	Options positioning signal	variable (VDC, on/off, floating point)
	Position feedback U	2...10 V
	Position feedback U note	Max. 0.5 mA
	Position feedback U variable	VDC variable
	Direction of motion motor	selectable with switch 0/1
	Manual override	external push button
	Angle of rotation	90°
	Angle of rotation note	adjustable with mechanical stop
	Running Time (Motor)	default 150 s, variable 35...150 s
	Running time motor variable	35...150 s
	Noise level, motor	35 dB(A)
Position indication	Mechanically, pluggable	
Safety data	Degree of protection IEC/EN	IP54
	Degree of protection NEMA/UL	NEMA 2 UL Enclosure Type 2
	Agency Listing	cULus acc. to UL60730-1A/-2-14, CAN/CSA E60730-1:02, CE acc. to 2014/30/EU
	Quality Standard	ISO 9001
	Ambient temperature	-22...122°F [-30...50°C]
	Storage temperature	-40...176°F [-40...80°C]
	Ambient humidity	max. 95% r.H., non-condensing
	Servicing	maintenance-free
Weight	Weight	1.5 lb [0.70 kg]

Safety notes



- 3/8"-16 shaft clevis for AHK/AH.
- Battery Back Up System for SY(7-10)-110
- 5/16" shaft clevis for LH.
- Cable to ZIP-RS232 US to diagnostic/programming socket.
- MFT95 resistor kit for 4 to 20 mA control applications.

Accessories

Gateways	Description	Type
	Gateway MP to BACnet MS/TP	UK24BAC
	Gateway MP to LonWorks	UK24LON
	Gateway MP to Modbus RTU	UK24MOD
Service tools	Description	Type
	Connection cable 10 ft [3 m], A: RJ11 6/4 ZTH EU, B: 3-pin Weidmüller and supply connection	ZK4-GEN
	Service Tool, with ZIP-USB function, for parametrisable and communicative Belimo actuators, VAV controller and HVAC performance devices	ZTH US

Electrical installation

✂ INSTALLATION NOTES

- 1 Provide overload protection and disconnect as required.
- 2 Actuators may be connected in parallel. Power consumption and input impedance must be observed.
- 3 Actuators may also be powered by 24 VDC.
- 5 Only connect common to negative (-) leg of control circuits.
- 7 A 500 Ω resistor (ZG-R01) converts the 4...20 mA control signal to 2...10 V.
- 8 Control signal may be pulsed from either the Hot (Source) or Common (Sink) 24 V line.
- 10 For triac sink the Common connection from the actuator must be connected to the Hot connection of the controller. Position feedback cannot be used with a triac sink controller; the actuator internal common reference is not compatible.
- 12 IN4004 or IN4007 diode. (IN4007 supplied, Belimo part number 40155).
- 18 Actuators with plenum cable do not have numbers; use color codes instead.
- ◆ Meets cULus requirements without the need of an electrical ground connection.
- ⚠ **Warning! Live Electrical Components!**
During installation, testing, servicing and troubleshooting of this product, it may be necessary to work with live electrical components. Have a qualified licensed electrician or other individual who has been properly trained in handling live electrical components perform these tasks. Failure to follow all electrical safety precautions when exposed to live electrical components could result in death or serious injury.

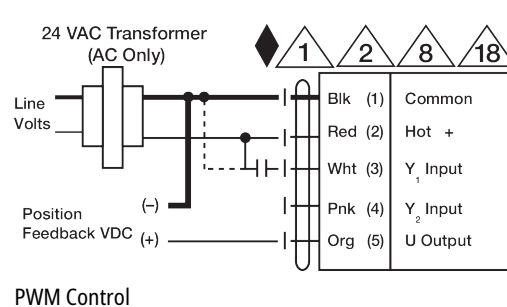
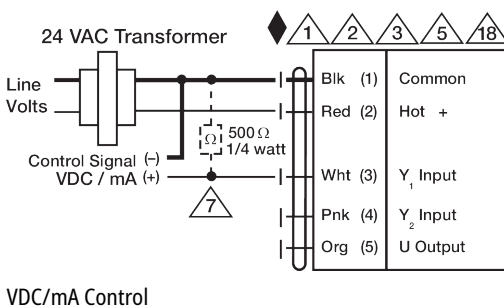
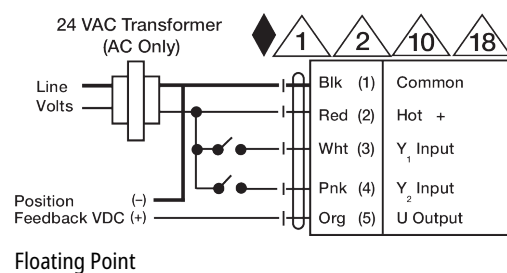
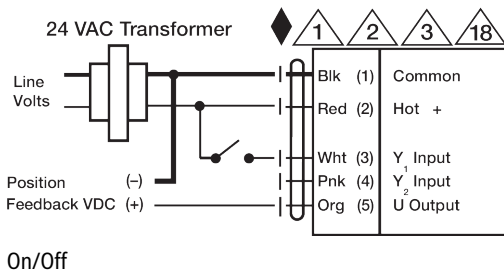

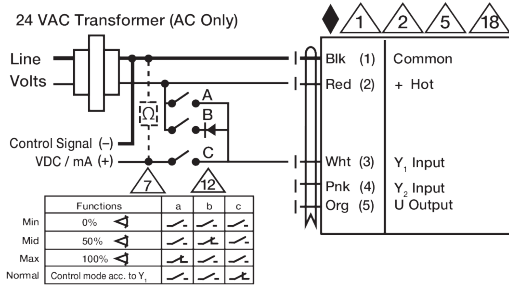

Override Control