



5-year warranty



Type overview

Type	DN
B261	65

Technical data

Functional data	Valve size [mm]	2.5" [65]
	Fluid	chilled or hot water, up to 60% glycol
	Fluid Temp Range (water)	0...212°F [-18...100°C]
	Body Pressure Rating	400 psi
	Close-off pressure Δps	100 psi
	Flow characteristic	equal percentage
	Pipe connection type	Internal thread NPT (female)
	Servicing	maintenance-free
	Flow Pattern	2-way
	Leakage rate	0% for A – AB
	Controllable flow range	75°
	Cv	60
	Materials	Valve body
Stem		stainless steel
Stem seal		EPDM (lubricated)
Seat		PTFE
Characterized disc		TEFZEL®
O-ring		EPDM (lubricated)
Ball		stainless steel
Suitable actuators	Non-Spring	ARB(X)
	Spring	AFRB(X)

Safety notes



- WARNING: This product can expose you to lead which is known to the State of California to cause cancer and reproductive harm. For more information go to www.p65warnings.ca.gov

Product features

Application This valve is typically used in air handling units on heating or cooling coils, and fan coil unit heating or cooling coils. Some other common applications include Unit Ventilators, VAV box re-heat coils and bypass loops. This valve is suitable for use in a hydronic system with variable flow.

Flow/Mounting details



Two-way valves should be installed with the disc upstream.

Dimensions

Type	DN	Weight
B261	65	8.1 lb [3.7 kg]

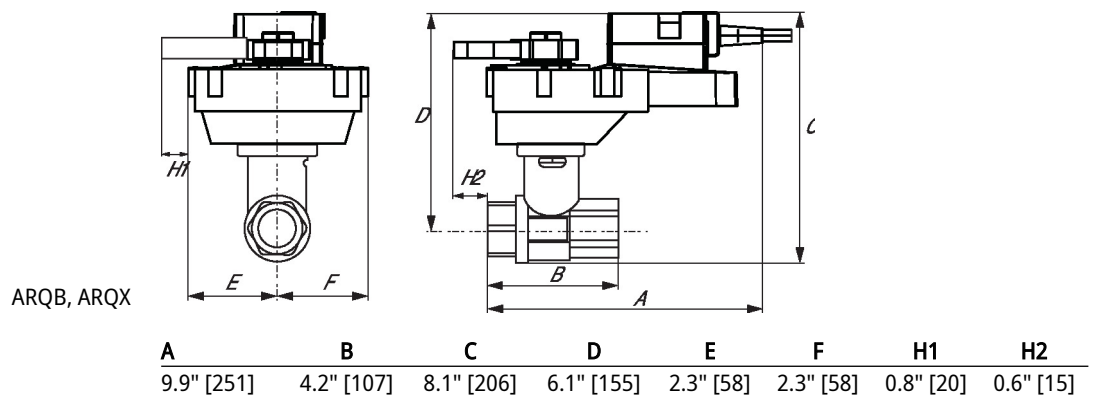
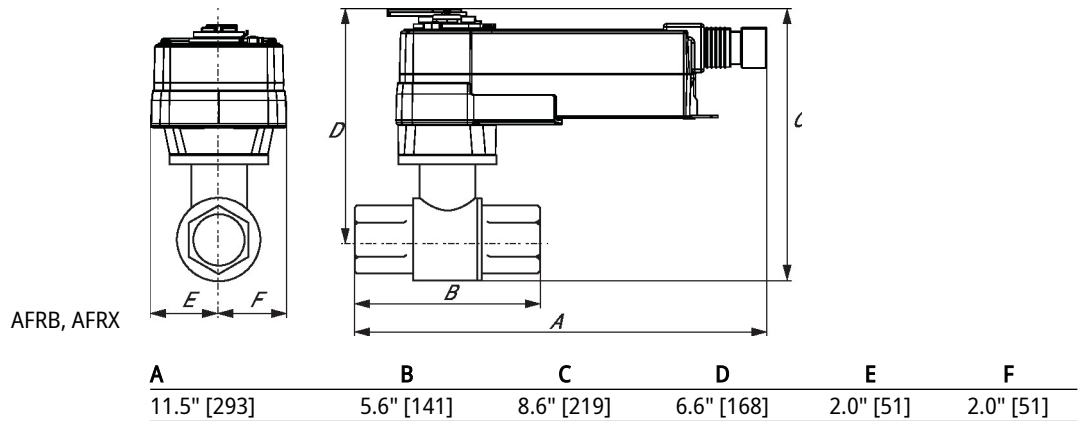
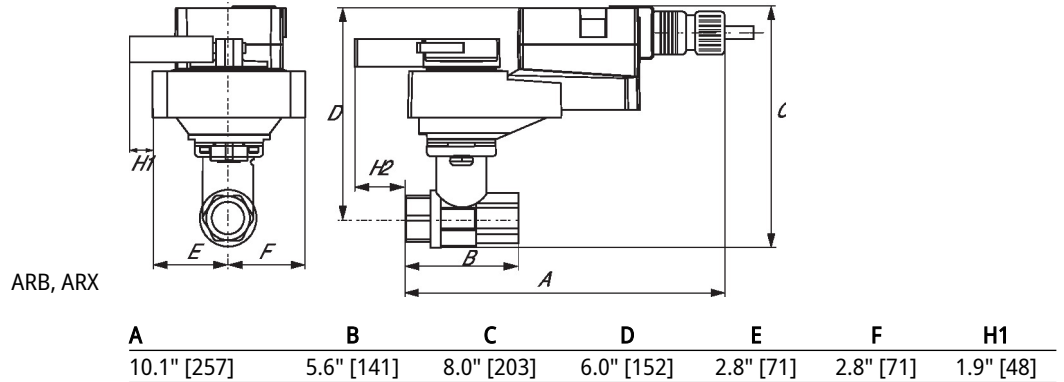

AFRB N4, AFRX N4

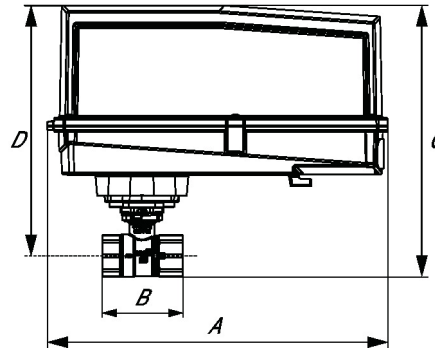

A	B	D	E	F
11.4" [289]	5.6" [141]	8.0" [203]	2.4" [62]	2.4" [62]

ARB N4, ARX N4, NRB N4, NRX N4

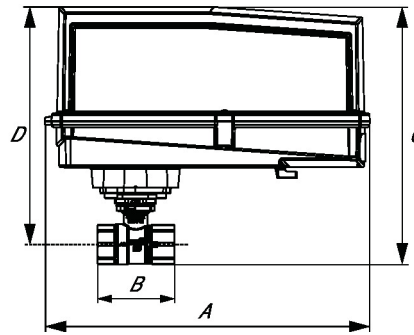
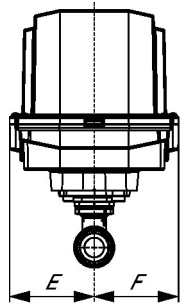

A	B	D	E	F
11.4" [289]	5.6" [141]	8.0" [203]	3.1" [80]	3.1" [80]