



5-year warranty



Type overview

Type	DN
B315B	15

Technical data

<b>Functional data</b>	Valve size [mm]	0.5" [15]
	Fluid	chilled or hot water, up to 60% glycol
	Fluid Temp Range (water)	0...250°F [-18...120°C]
	Body Pressure Rating	600 psi
	Close-off pressure Δps	200 psi
	Flow	A-port: as stated in chart B-port: 70% of A – AB Cv
	Flow characteristic	A-port Equal percentage; B-port modified linear for constant flow
	Servicing	maintenance-free
	Flow Pattern	3-way Mixing/Diverting
	Leakage rate	0% for A – AB, <2.0% for B – AB
	Controllable flow range	75°
	Cv	10
	<b>Materials</b>	Valve body
Stem		nickel-plated brass
Stem seal		EPDM (lubricated)
Seat		PTFE
Characterized disc		TEFZEL®
Pipe connection		NPT
O-ring		EPDM (lubricated)
Ball		chrome plated brass
<b>Suitable actuators</b>	Non-Spring	TR LRB(X)
	Spring	TFB(X) LF

Safety notes



- WARNING: This product can expose you to lead which is known to the State of California to cause cancer and reproductive harm. For more information go to [www.p65warnings.ca.gov](http://www.p65warnings.ca.gov)

Product features

**Application** This valve is typically used in air handling units on heating or cooling coils, and fan coil unit heating or cooling coils. Some other common applications include Unit Ventilators, VAV box re-heat coils and bypass loops. This valve is suitable for use in a hydronic system with variable or constant flow.

Flow/Mounting details



Dimensions

Type	DN	Weight
B315B	15	0.66 lb [0.30 kg]

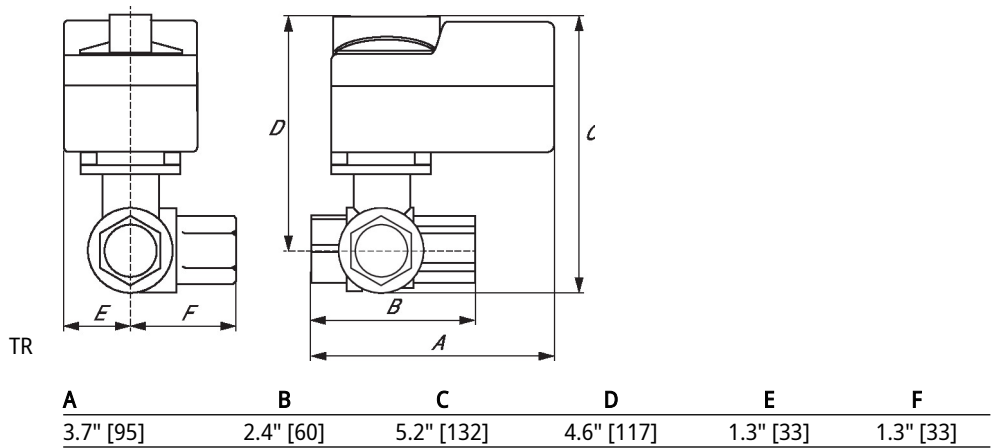
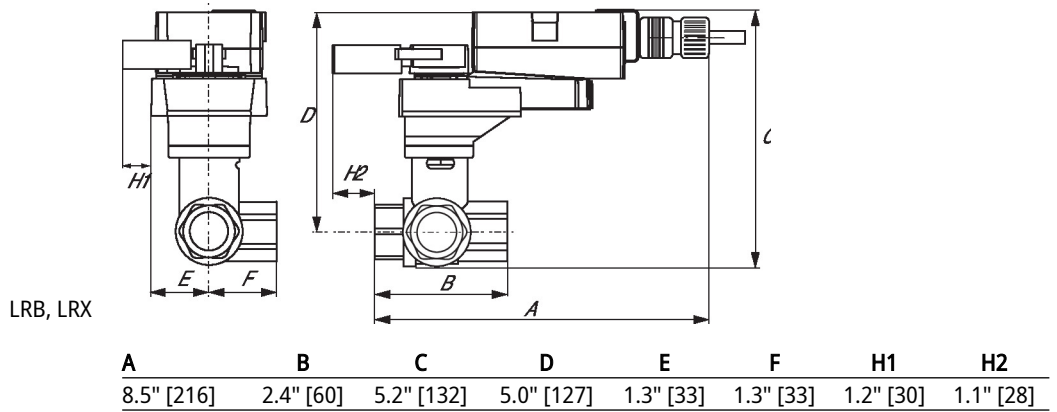

A	B	C	D	E	F
6.6" [167]	2.4" [60]	4.9" [124]	4.7" [120]	1.5" [39]	1.3" [33]



A	B	C	D	E	F
7.9" [200]	2.4" [60]	6.1" [154]	5.5" [140]	1.8" [46]	1.9" [48]



5-year warranty



## Technical data

<b>Electrical data</b>	Nominal voltage	AC/DC 24 V	
	Nominal voltage frequency	50/60 Hz	
	Nominal voltage range	AC 19.2...28.8 V / DC 21.6...28.8 V	
	Power consumption in operation	2.5 W	
	Power consumption in rest position	1 W	
	Transformer sizing	5 VA	
	Electrical Connection	18 GA plenum cable, 1 m, with 1/2" conduit connector	
	Overload Protection	electronic throughout 0...95° rotation	
<b>Functional data</b>	Operating range Y	2...10 V	
	Operating range Y note	4...20 mA w/ ZG-R01 (500 Ω, 1/4 W resistor)	
	Input Impedance	100 kΩ for 2...10 V (0.1 mA), 500 Ω for 4...20 mA	
	Position feedback U	2...10 V	
	Position feedback U note	Max. 0.7 mA	
	Direction of motion motor	selectable with switch 0/1	
	Direction of motion fail-safe	reversible with cw/ccw mounting	
	Angle of rotation	90°	
	Running Time (Motor)	150 s / 90°	
	Running time motor note	constant, independent of load	
	Running time fail-safe	<25 s @ -4...122°F [-20...50°C], <60 s @ -22°F [-30°C]	
	Noise level, motor	50 dB(A)	
	Noise level, fail-safe	62 dB(A)	
	Position indication	Mechanical	
<b>Safety data</b>	Power source UL	Class 2 Supply	
	Degree of protection IEC/EN	IP54	
	Degree of protection NEMA/UL	NEMA 2	
	Enclosure	UL Enclosure Type 2	
	Agency Listing	cULus acc. To UL 873 and CAN/CSA C22.2 No. 24-93	
	Quality Standard	ISO 9001	
	UL 2043 Compliant	Suitable for use in air plenums per Section 300.22(C) of the NEC and Section 602 of the IMC	
	Ambient humidity	Max. 95% RH, non-condensing	
	Ambient temperature	-22...122°F [-30...50°C]	
	Storage temperature	-40...176°F [-40...80°C]	
	Servicing	maintenance-free	
	<b>Weight</b>	Weight	3.4 lb [1.5 kg]
		<b>Materials</b>	Housing material

Footnotes †Rated Impulse Voltage 800V, Type of action 1.AA, Control Pollution Degree 3

Electrical installation

**✂ INSTALLATION NOTES**

- (A)** Actuators with appliance cables are numbered.
- (1)** Provide overload protection and disconnect as required.
- (3)** Actuators may also be powered by DC 24 V.
- (5)** Only connect common to negative (-) leg of control circuits.
- (7)** A 500 Ω resistor (ZG-R01) converts the 4...20 mA control signal to 2...10 V.
- (11)** Actuators may be connected in parallel if not mechanically linked. Power consumption and input impedance must be observed.
- ◆** Meets cULus requirements without the need of an electrical ground connection.
- (1) Warning! Live electrical components!**  
During installation, testing, servicing and troubleshooting of this product, it may be necessary to work with live electrical components. Have a qualified licensed electrician or other individual who has been properly trained in handling live electrical components perform these tasks. Failure to follow all electrical safety precautions when exposed to live electrical components could result in death or serious injury.

**Wiring diagrams**

2...10 V / 4...20 mA Control

