



5-year warranty



Technical data

| | | |
|---------------------------|---------------------------|--|
| Functional data | Valve Size | 1" [25] |
| | Fluid | chilled or hot water, up to 60% glycol |
| | Fluid Temp Range (water) | 0...250°F [-18...120°C] |
| | Body Pressure Rating | 600 psi |
| | Body pressure rating note | 600 psi |
| | Close-off pressure Δps | 200 psi |
| | Flow characteristic | A-port equal percentage, B-port modified for constant common port flow |
| | Servicing | maintenance-free |
| | Flow Pattern | 3-way Mixing/Diverting |
| | Leakage rate | 0% for A – AB, <2.0% for B – AB |
| | Controllable flow range | 75° |
| | Cv | 10 |
| | Cv Flow Rating | A-port: as stated in chart B-port: 70% of A – AB Cv |
| Materials | Valve body | Nickel-plated brass body |
| | Stem | stainless steel |
| | Stem seal | EPDM (lubricated) |
| | Seat | PTFE |
| | Characterizing disk | TEFZEL® |
| | Pipe connection | NPT female ends |
| | O-ring | EPDM (lubricated) |
| | Ball | stainless steel |
| Suitable actuators | Non-Spring | LRB(X) NRB(X) N4 |
| | Spring | LF |

Safety notes



- WARNING: This product can expose you to lead which is known to the State of California to cause cancer and reproductive harm. For more information go to www.p65warnings.ca.gov

Product features

Application This valve is typically used in air handling units on heating or cooling coils, and fan coil unit heating or cooling coils. Some other common applications include Unit Ventilators, VAV box re-heat coils and bypass loops. This valve is suitable for use in a hydronic system with variable or constant flow.

Flow/Mounting details



Dimensions

Dimensional drawings

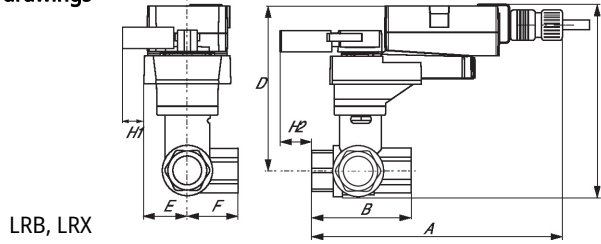

LRB, LRX

Type

DN

Weight [kg]
[kg]

B323

25

0.60

| A | B | C | D | E | F | H1 | H2 |
|------------|-----------|------------|------------|-----------|-----------|-----------|-----------|
| 8.5" [216] | 3.1" [78] | 5.9" [150] | 5.1" [129] | 1.3" [33] | 1.6" [40] | 1.2" [30] | 0.9" [23] |

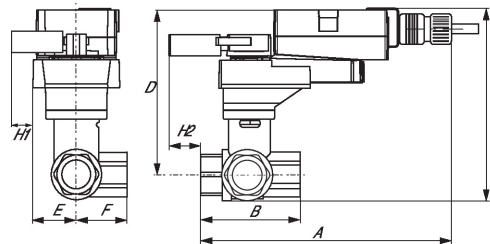

LRB, LRX

| A | B | C | D | E | F | H1 | H2 |
|------------|-----------|------------|------------|-----------|-----------|-----------|-----------|
| 9.4" [239] | 3.1" [78] | 7.2" [184] | 6.3" [161] | 1.3" [33] | 1.3" [33] | 1.2" [30] | 0.9" [23] |

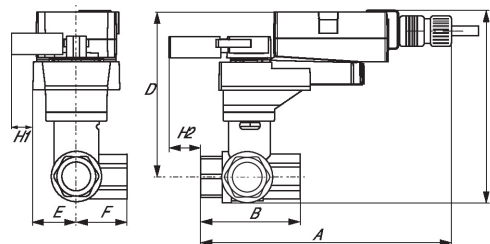

LRQB, LRQX

| A | B | C | D | E | F | H1 | H2 |
|------------|-----------|------------|------------|-----------|-----------|-----------|---------|
| 8.9" [226] | 3.1" [78] | 6.7" [169] | 5.6" [142] | 1.6" [40] | 1.6" [40] | 1.2" [30] | 1" [25] |

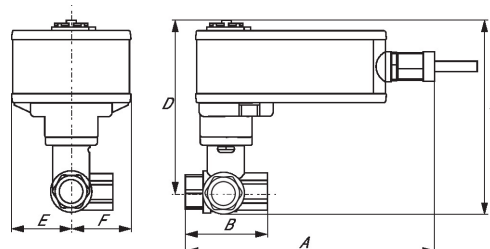

LF

| A | B | C | D | E | F |
|------------|-----------|------------|------------|-----------|-----------|
| 8.1" [206] | 3.1" [78] | 6.5" [165] | 5.6" [142] | 1.9" [48] | 1.9" [48] |



5-year warranty



Technical data

| | | |
|------------------------|------------------------------------|---|
| Electrical data | Nominal voltage | AC/DC 24 V |
| | Nominal voltage frequency | 50/60 Hz |
| | Power consumption in operation | 1.5 W |
| | Power consumption in rest position | 0.2 W |
| | Power consumption for wire sizing | 2 VA |
| | Transformer sizing | 2.5 VA (class 2 power source) |
| | Electrical Connection | Screw terminal (for 26 to 14 GA wire) |
| | Overload Protection | electronic throughout 0...90° rotation |
| Functional data | Direction of motion motor | selectable with switch 0/1 |
| | Manual override | external push button |
| | Angle of rotation | 90° |
| | Angle of rotation note | adjustable with mechanical stop |
| | Running Time (Motor) | 90 s |
| | Noise level, motor | 35 dB(A) |
| | Position indication | Mechanically, pluggable |
| Safety data | Degree of protection IEC/EN | IP54 |
| | Degree of protection NEMA/UL | NEMA 1 |
| | Enclosure | UL Enclosure Type 1 |
| | Agency Listing | cULus acc. to UL60730-1A/-2-14, CAN/CSA E60730-1:02, CE acc. to 2014/30/EU Listed to UL 2043 - suitable for use in air plenums per Section 300.22(C) of the NEC and Section 602 of the IMC |
| | Quality Standard | ISO 9001 |
| | Ambient temperature | -22...122°F [-30...50°C] |
| | Storage temperature | -40...176°F [-40...80°C] |
| | Ambient humidity | Max. 95% RH, non-condensing |
| | Servicing | maintenance-free |
| | Weight | Weight |

Accessories

| Electrical accessories | Description | Type |
|------------------------|---|------------|
| | Battery backup system, for non-spring return models | NSV24 US |
| | Battery, 12 V, 1.2 Ah (two required) | NSV-BAT |
| | Auxiliary switch 1 x SPDT add-on | S1A |
| | Auxiliary switch 2 x SPDT add-on | S2A |
| | Feedback potentiometer 140 Ω add-on, grey | P140A GR |
| | Feedback potentiometer 1 kΩ add-on, grey | P1000A GR |
| | Feedback potentiometer 10 kΩ add-on, grey | P10000A GR |
| | Feedback potentiometer 2.8 kΩ add-on, grey | P2800A GR |
| | Feedback potentiometer 500 Ω add-on, grey | P500A GR |
| | Feedback potentiometer 5 kΩ add-on, grey | P5000A GR |

Electrical installation

✂ INSTALLATION NOTES

- 1** Provide overload protection and disconnect as required.
- 2** Actuators may be connected in parallel. Power consumption and input impedance must be observed.
- 3** Actuators may also be powered by DC 24 V.
- 6** Actuators Hot wire must be connected to the control board common. Only connect common to neg. (-) leg of control circuits. Terminal models (-T) have no-feedback.
- 16** Actuators are provided with a numbered screw terminal strip instead of a cable.
- ◆** Meets cULus requirements without the need of an electrical ground connection.
- ⚠ Warning! Live electrical components!**
During installation, testing, servicing and troubleshooting of this product, it may be necessary to work with live electrical components. Have a qualified licensed electrician or other individual who has been properly trained in handling live electrical components perform these tasks. Failure to follow all electrical safety precautions when exposed to live electrical components could result in death or serious injury.

Wiring diagrams

On/Off

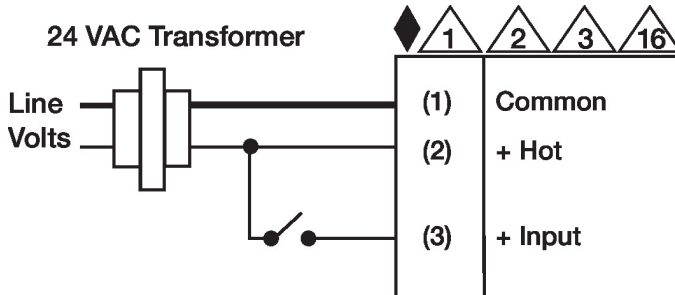

Floating Point

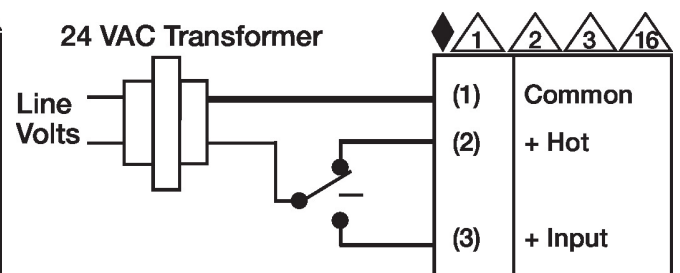

Floating Point - Triac Source
24 VAC Transformer

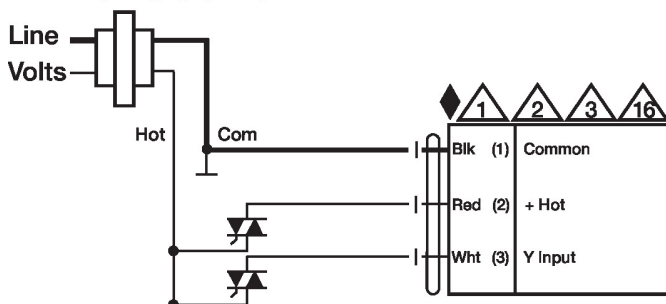

Floating Point - Triac Sink
24 VAC Transformer

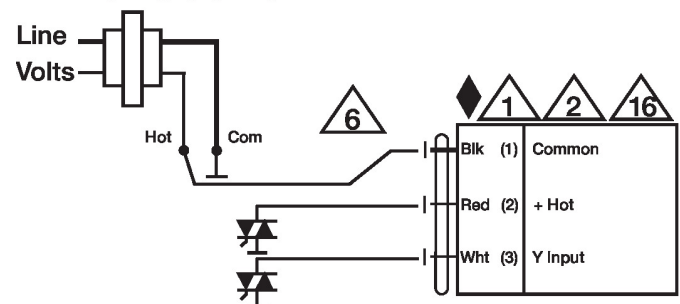

Installation notes

Servicing

