

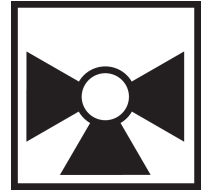

5-year warranty



Technical data

| | | |
|---------------------------|--------------------------------|--|
| Functional data | Valve Size | 1.25" [32] |
| | Fluid | chilled or hot water, up to 60% glycol |
| | Fluid Temp Range (water) | 0...250°F [-18...120°C] |
| | Body Pressure Rating | 400 psi |
| | Close-off pressure Δ ps | 200 psi |
| | Flow characteristic | A-port equal percentage, B-port modified for constant common port flow |
| | Servicing | maintenance-free |
| | Flow Pattern | 3-way Mixing/Diverting |
| | Leakage rate | 0% for A – AB, <2.0% for B – AB |
| | Controllable flow range | 75° |
| | Cv | 25 |
| | Body pressure rating note | 400 psi |
| | Cv Flow Rating | A-port: as stated in chart B-port: 70% of A – AB Cv |
| Materials | Valve body | Nickel-plated brass body |
| | Stem seal | EPDM (lubricated) |
| | Seat | PTFE |
| | Pipe connection | NPT female ends |
| | O-ring | EPDM (lubricated) |
| | Ball | stainless steel |
| Suitable actuators | Non-Spring | ARB(X) |

Safety notes



- **WARNING:** This product can expose you to lead which is known to the State of California to cause cancer and reproductive harm. For more information go to www.p65warnings.ca.gov

Product features

- Application** This valve is typically used in air handling units on heating or cooling coils, and fan coil unit heating or cooling coils. Some other common applications include Unit Ventilators, VAV box re-heat coils and bypass loops. This valve is suitable for use in a hydronic system with variable or constant flow.

Flow/Mounting details



Dimensions

Dimensional drawings



ARB, ARX

| A | B | C | D | E | F | H1 | H2 |
|-------------|------------|------------|------------|-----------|-----------|-----------|-----------|
| 10.0" [254] | 4.0" [101] | 6.8" [172] | 5.5" [140] | 1.7" [44] | 2.1" [54] | 0.8" [20] | 0.6" [15] |

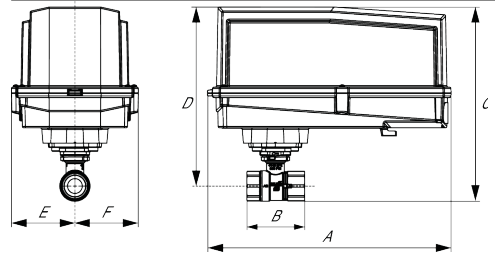

ARB N4, ARX N4, NRB N4, NRX N4

| A | B | C | D | E | F |
|-------------|------------|------------|------------|-----------|-----------|
| 11.4" [289] | 4.0" [101] | 8.9" [226] | 7.6" [194] | 3.1" [80] | 3.1" [80] |

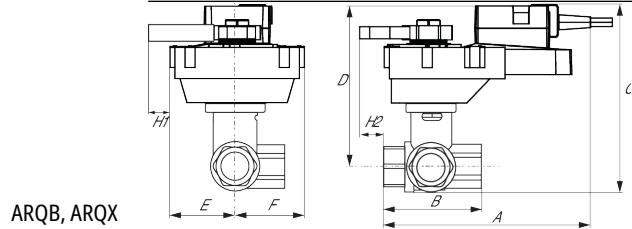

ARQB, ARQX

| A | B | C | D | E | F | H1 | H2 |
|------------|------------|------------|------------|-----------|-----------|-----------|-----------|
| 9.7" [246] | 4.0" [101] | 7.5" [191] | 6.2" [158] | 1.7" [44] | 2.1" [54] | 1.4" [34] | 0.8" [20] |

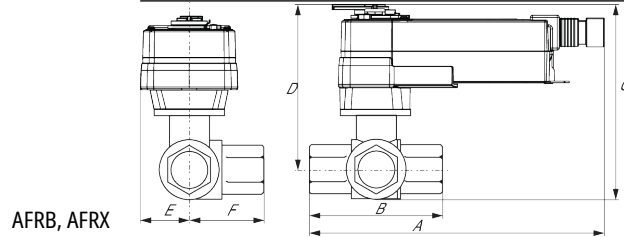

AFRB, AFRX

| A | B | C | D | E | F |
|-------------|------------|------------|------------|-----------|-----------|
| 10.6" [269] | 4.0" [101] | 6.9" [175] | 5.7" [146] | 2.1" [54] | 1.3" [33] |

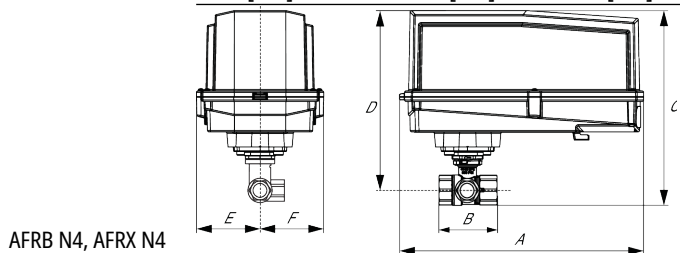

AFRB N4, AFRX N4

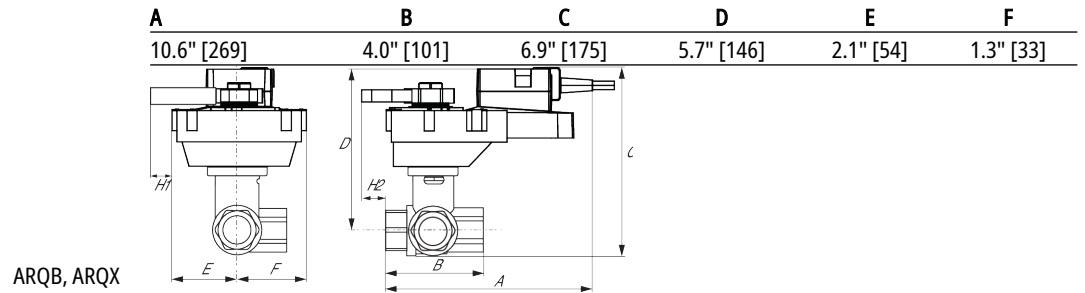
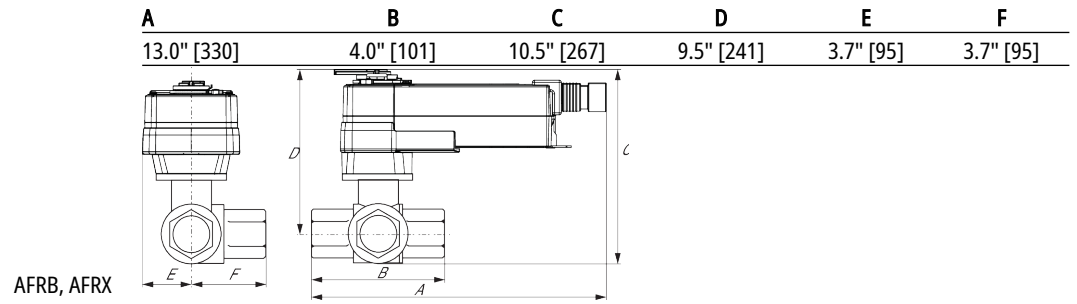

| A | B | C | D | E | F |
|-------------|------------|-------------|------------|-----------|-----------|
| 13.0" [330] | 4.0" [101] | 10.5" [267] | 9.5" [241] | 3.7" [95] | 3.7" [95] |



5-year warranty







Technical data

| | | |
|------------------------|------------------------------------|--|
| Electrical data | Nominal voltage | AC/DC 24 V |
| | Nominal voltage frequency | 50/60 Hz |
| | Power consumption in operation | 15 W |
| | Power consumption in rest position | 1.5 W |
| | Transformer sizing | 23 VA (class 2 power source) |
| | Electrical Connection | 18 GA plenum cable, 3 ft [1 m], with 1/2" conduit connector (10 ft [3 m] and 15 ft [5 m] available) |
| | Overload Protection | electronic throughout 0...95° rotation |
| Functional data | Input Impedance | 600 Ω |
| | Direction of motion motor | selectable with switch 0/1 |
| | Manual override | external push button |
| | Angle of rotation | 90° |
| | Angle of rotation note | adjustable with mechanical stop |
| | Running Time (Motor) | default 10 s, variable 15 s |
| | Running time motor variable | 15 s |
| | Noise level, motor | 52 dB(A) |
| Position indication | Mechanically, pluggable | |
| Safety data | Degree of protection IEC/EN | IP54 |
| | Degree of protection NEMA/UL | NEMA 2 UL Enclosure Type 2 |
| | Agency Listing | cULus acc. to UL60730-1A/-2-14, CAN/CSA E60730-1:02, CE acc. to 2014/30/EU and 2014/35/EU; Listed to UL 2043 - suitable for use in air plenums per Section 300.22(c) of the NEC and Section 602.2 of the IMC |
| | Quality Standard | ISO 9001 |
| | Ambient temperature | -22...122°F [-30...50°C] |
| | Storage temperature | -40...176°F [-40...80°C] |
| | Ambient humidity | max. 95% r.H., non-condensing |
| | Servicing | maintenance-free |
| Weight | Weight | 2.9 lb [1.3 kg] |

Electrical installation

 **INSTALLATION NOTES**

-  Provide overload protection and disconnect as required.
-  Actuators may be connected in parallel. Power consumption and input impedance must be observed.
-  Actuators may also be powered by 24 VDC.
-  Actuators with plenum cable do not have numbers; use color codes instead.
-  Meets cULus requirements without the need of an electrical ground connection.

⚠ Warning! Live Electrical Components!

During installation, testing, servicing and troubleshooting of this product, it may be necessary to work with live electrical components. Have a qualified licensed electrician or other individual who has been properly trained in handling live electrical components perform these tasks. Failure to follow all electrical safety precautions when exposed to live electrical components could result in death or serious injury.

