



5-year warranty



Type overview

Type	DN
B338	40

Technical data

Functional data	Valve size	1.5" [40]
	Fluid	chilled or hot water, up to 60% glycol
	Fluid Temp Range (water)	0...250°F [-18...120°C]
	Body Pressure Rating	400 psi
	Close-off pressure Δps	200 psi
	Flow characteristic	A-port equal percentage, B-port modified for constant common port flow
	Servicing	maintenance-free
	Flow Pattern	3-way Mixing/Diverting
	Leakage rate	0% for A – AB, <2.0% for B – AB
	Controllable flow range	75°
	Cv	19
	Cv Flow Rating	A-port: as stated in chart B-port: 70% of A – AB Cv
	Materials	Valve body
Stem		stainless steel
Stem seal		EPDM (lubricated)
Seat		PTFE
Characterized disc		TEFZEL®
Pipe connection		NPT female ends
O-ring		EPDM (lubricated)
Suitable actuators	Non-Spring	ARB(X)
	Spring	AF

Safety notes



- WARNING: This product can expose you to lead which is known to the State of California to cause cancer and reproductive harm. For more information go to www.p65warnings.ca.gov

Product features

Application This valve is typically used in air handling units on heating or cooling coils, and fan coil unit heating or cooling coils. Some other common applications include Unit Ventilators, VAV box re-heat coils and bypass loops. This valve is suitable for use in a hydronic system with variable or constant flow.

Flow/Mounting details



Product features

Mode of operation Local Control SY2-12, 110vac Mod

Dimensions

Type	DN
B338	40

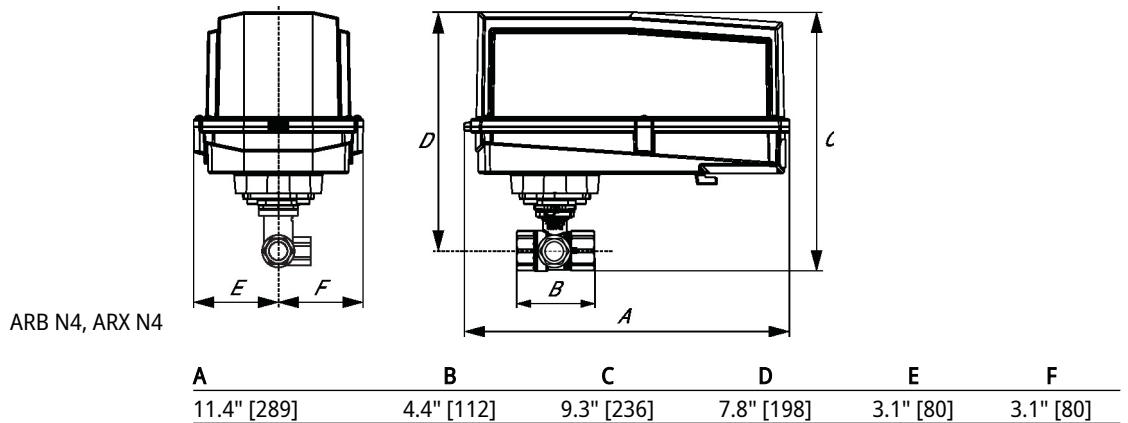
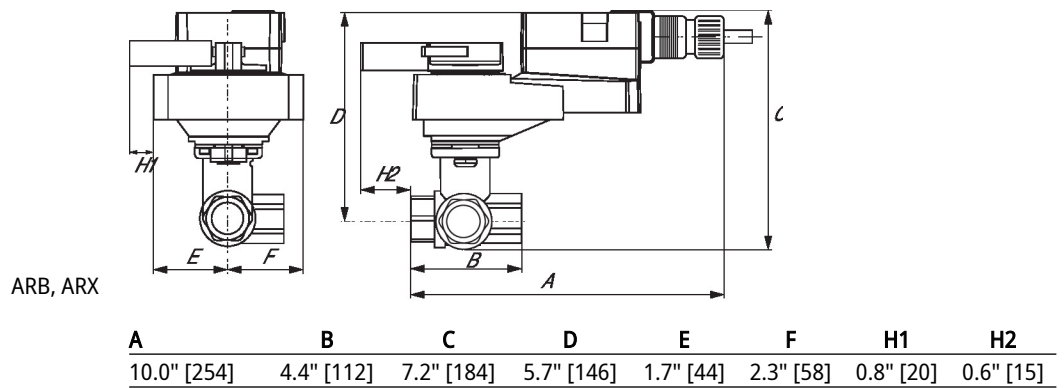

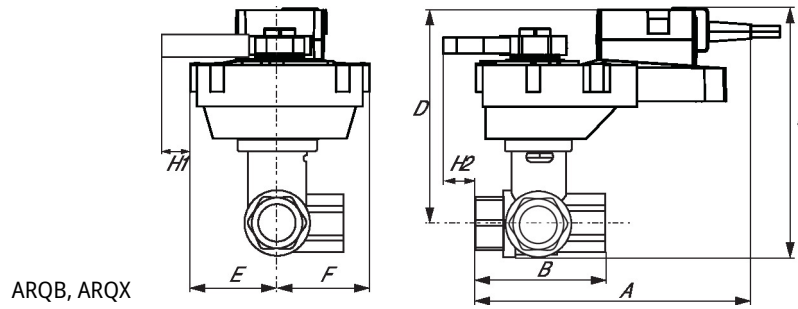

ARQB, ARQX

A	B	C	D	E	F	H1	H2
9.9" [251]	4.4" [112]	7.8" [199]	6.3" [161]	2.3" [58]	2.3" [58]	0.8" [20]	0.8" [20]

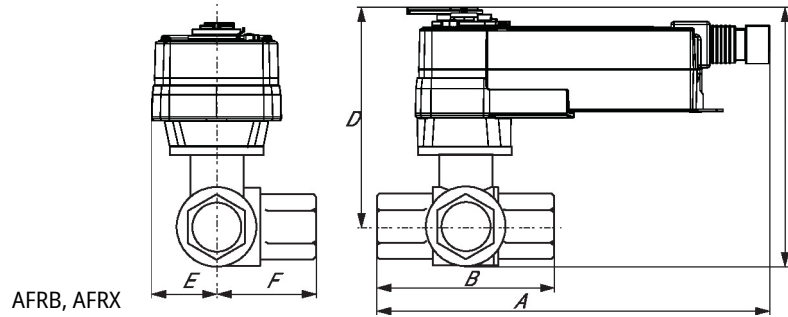

AFRB, AFRX

A	B	C	D	E	F
10.8" [275]	4.4" [112]	7.9" [201]	6.4" [162]	2.3" [58]	2.3" [58]

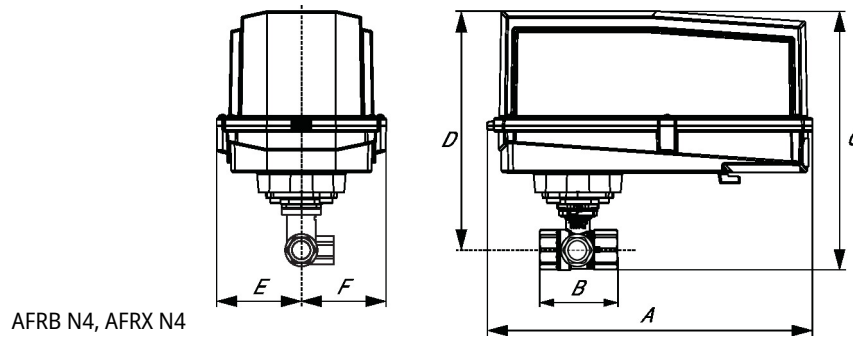

AFRB N4, AFRX N4

A	B	C	D	E	F
13.0" [330]	4.4" [112]	11.2" [284]	9.7" [246]	3.7" [95]	3.7" [95]



5-year warranty



Technical data

Electrical data	Nominal voltage	AC/DC 24 V
	Nominal voltage frequency	50/60 Hz
	Power consumption in operation	5 W
	Power consumption in rest position	2.5 W
	Transformer sizing	7.5 VA (class 2 power source)
	Electrical Connection	18 GA appliance cable, 3 ft [1 m], with 1/2" conduit connector
	Overload Protection	electronic throughout 0...95° rotation
Functional data	Direction of motion motor	selectable by ccw/cw mounting
	Direction of motion fail-safe	reversible with cw/ccw mounting
	Manual override	5 mm hex crank (3/16" Allen), supplied
	Angle of rotation	90°
	Running Time (Motor)	75 s / 90°
	Running time fail-safe	<20 s
	Noise level, motor	45 dB(A)
	Noise level, fail-safe	62 dB(A)
	Position indication	Mechanical
Safety data	Degree of protection IEC/EN	IP66
	Degree of protection NEMA/UL	NEMA 4X
	Enclosure	UL Enclosure Type 4X
	Agency Listing	cULus acc. to UL60730-1A/-2-14, CAN/CSA E60730-1:02, CE acc. to 2014/30/EU and 2014/35/EU
	Quality Standard	ISO 9001
	Ambient temperature	-22...122°F [-30...50°C]
	Ambient temperature note	-40...50°C for actuator with integrated heating
	Storage temperature	-40...176°F [-40...80°C]
	Ambient humidity	Max. 100% RH
	Servicing	maintenance-free
Materials	Housing material	Die cast aluminium and plastic casing

Footnotes †Rated Impulse Voltage 800V, Type of action 1.AA, Control Pollution Degree 3

Electrical installation

 **INSTALLATION NOTES**

 Actuators with appliance cables are numbered.

 Provide overload protection and disconnect as required.

- Actuators may also be powered by DC 24 V.
- Actuators may be powered in parallel. Power consumption must be observed.
- Parallel wiring required for piggy-back applications.
- Meets cULus requirements without the need of an electrical ground connection.

Warning! Live electrical components!
 During installation, testing, servicing and troubleshooting of this product, it may be necessary to work with live electrical components. Have a qualified licensed electrician or other individual who has been properly trained in handling live electrical components perform these tasks. Failure to follow all electrical safety precautions when exposed to live electrical components could result in death or serious injury.

Wiring diagrams

On/Off



Dimensions