

Differential pressure sensor Air

Differential pressure transmitter with 8 selectable ranges and outputs 0...5 V, 0...10 V or 4...20 mA. For monitoring the differential pressure of air and other non-flammable and non-aggressive gases. Typical application in HVAC systems for monitoring air filters, fans V-belts or fire and smoke control dampers. Options available with LCD display. NEMA 4X / IP65 rated enclosure.



5-year warranty

Type Overview

Type	Measuring range [Pa]	Measuring range [inch WC]	Output signal active pressure	Burst pressure	Display type
22ADP-586	0...7000	0...28	0...5 V, 0...10 V, 4...20 mA	160 inch WC [40 kPa]	-
22ADP-586L	0...7000	0...28	0...5 V, 0...10 V, 4...20 mA	160 inch WC [40 kPa]	LCD

Technical data

Electrical Data	Nominal voltage	AC/DC 24 V
	Nominal voltage range	AC 19...29 V / DC 15...35 V
	Power consumption AC	4.3 VA
	Power consumption DC	2.3 W
	Electrical connection	Pluggable spring-loaded terminal block max. 2.5 mm ²
	Cable entry	Cable gland with strain relief ø6...8 mm (1/2" NPT conduit adapter included)
Functional Data	Application	Air
	Multirange	8 measuring ranges selectable
	Voltage output	1 x 0...5 V, 0...10 V, min. resistance 10 kΩ
	Current output	1x 4...20 mA, max. resistance 500 Ω
	Output signal active note	Output 0...5/10 V selectable with switch
	Display	LCD, 1.14x1.38" [29x35 mm] with backlight Measured values: Pa, inch WC (programmable)
Typical response time	adjustable 0.8 s or 4.0 s	
Measuring Data	Measured values	Differential pressure Volumetric flow (with A-22G-A05)
	Measuring fluid	air and non-aggressive gases
Specification pressure	Sensing element technology	piezo measuring element

Technical data

Specification pressure	Measuring range pressure settings	Setting	Range [Pa]	Range [inch WC]	Factory setting
		S0	0...7000	0...28	✓
		S1	0...5000	0...20	
		S2	0...4000	0...16	
		S3	0...3000	0...12	
		S4	0...2500	0...10	
		S5	0...2000	0...8	
		S6	0...1500	0...6	
		S7	0...1000	0...4	
	Accuracy	measuring range ≤8 inch WC: ±0.04 inch WC measuring range >8 inch WC: ±0.1 inch WC			
	Long term stability	±2.5% FSO (Full Scale Output) / 4 yr.			
Safety Data	Protection class IEC/EN	III, Safety Extra-Low Voltage (SELV)			
	Power source UL	Class 2 Supply			
	Degree of protection IEC/EN	IP65			
	Degree of protection NEMA/UL	NEMA 4X			
	Enclosure	UL Enclosure Type 4X			
	EU Conformity	CE Marking			
	Certification IEC/EN	IEC/EN 60730-1 and IEC/EN 60730-2-6			
	Quality Standard	ISO 9001			
	UL 2043 Compliant	Suitable for use in air plenums per Section 300.22(C) of the NEC and Section 602 of the IMC			
	Type of action	Type 1			
	Rated impulse voltage supply	0.8 kV			
	Pollution degree	3			
	Ambient humidity	Max. 95% RH, non-condensing			
	Ambient temperature	14...122°F [-10...50°C]			
Fluid temperature	15...120°F [-10...50°C]				
Storage temperature	-4...176°F [-20...80°C]				
Materials	Cable gland	PA6, black			
	Housing	Cover: PC, orange Bottom: PC, orange Seal: NBR70, black UV resistant UL94 5VA			

Safety Notes

This device has been designed for use in stationary heating, ventilation and air-conditioning systems and must not be used outside the specified field of application. Unauthorized modifications are prohibited. The product must not be used in relation with any equipment that in case of a failure may threaten humans, animals or assets.

Ensure all power is disconnected before installing. Do not connect to live/operating equipment.

Only authorized specialists may carry out installation. All applicable legal or institutional installation regulations must be complied with during installation.

The device contains electrical and electronic components and must not be disposed of as household refuse. All locally valid regulations and requirements must be observed.

Remarks

Manual zero-point calibration After initial commissioning

To carry out the zero-point calibration, the device must be connected to the power supply at least 15 minutes beforehand.

Calibration interval

- ≤1 inch WC 3 months
- ≤2 inch WC 6 months
- >2 inch WC 12 months

Procedure

- Release both tube connectors from the pressure ports + and - (Carry out the manual zero-point calibration even if the display shows 0.)
- Press the button "Manual zero-point calibration" until the LED lights up permanently
- Wait until the LED flashes again and reinstall the tube connectors to the pressure ports (pay attention to + and -)

Indicators and Operation

Indicators Depending on the device and the number of measured values, the display automatically scales. Parameters, such as the fading in/out of measured values, brightness and traffic light function, are changed via the app or bus system. During the boot process, the software and hardware versions are displayed.

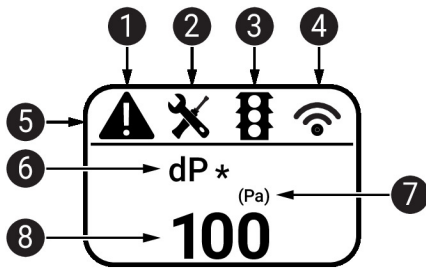

- 1 Fault / sensor failure
- 2 Service / visual inspection due
- 3 TLF (traffic light function) active (thresholds for display color changes)
- 4 Radio active (not available)
- 5 Status bar
- 6 Measured value (* appears when TLF function is activated for this value)
- 7 Unit of measure
- 8 Measured value

Parts included

Description	Type
Mounting plate L housing	A-22D-A10
Duct connector kit, PVC tube 2 m, 2x duct connector (plastic) for 22ADP-..	A-22AP-A08
Dowels	
Screws	
1/2" NPT conduit adapter	

Accessories

Optional accessories	Description	Type
	Duct connector, Metal, L 1.5", Tube connection 0.2"	A-22AP-A01
	Duct connector, Metal, L 4", Tube connection 0.2"	A-22AP-A03
Tools	Description	Type
	Belimo Duct Sensor Assistant App	Belimo Duct Sensor Assistant App

Accessories

Description	Type
Bluetooth dongle for Belimo Duct Sensor Assistant App	A-22G-A05
* Bluetooth dongle A-22G-A05	
Certified and available in North America, European Union, EFTA States and UK.	

Service

Tools connection This sensor can be operated and parametrized using the Belimo Assistant App. When using the Belimo Duct Sensor Assistant App, the Bluetooth dongle is required to enable communication between the app and the Belimo sensor.

For the standard operation and parametrization of the sensor the Bluetooth dongle and the Belimo Duct Sensor Assistant App are not needed. The sensor will arrive pre-configured with the factory default settings shown above.

Requirement:

- Bluetooth dongle (Belimo Part No: A-22G-A05)
- Bluetooth-capable smartphone
- Belimo Duct Sensor Assistant App (Google Play & Apple App Store)

Procedure:

- Plug the Bluetooth dongle into the sensor via the Micro-USB connector or by means of the interface PCB
- Connect Bluetooth-capable smartphone with Bluetooth dongle
- Select parametrization in the Belimo Assistant App

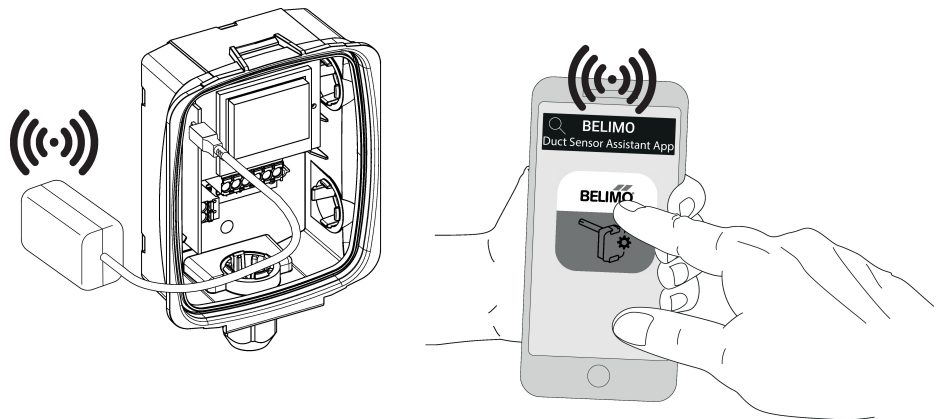

Wiring Diagram



Notes

When switching from 0...10 V to 0...5 V output voltage also the current will be adjusted from 4...20 mA to 4...12 mA.

Wiring Diagram

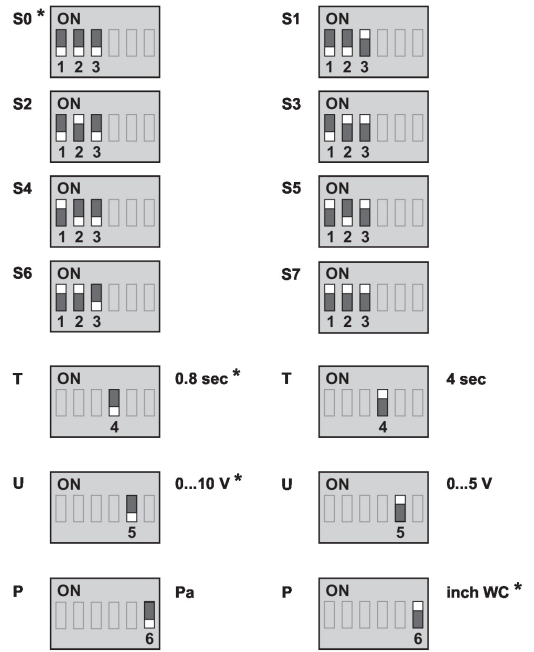
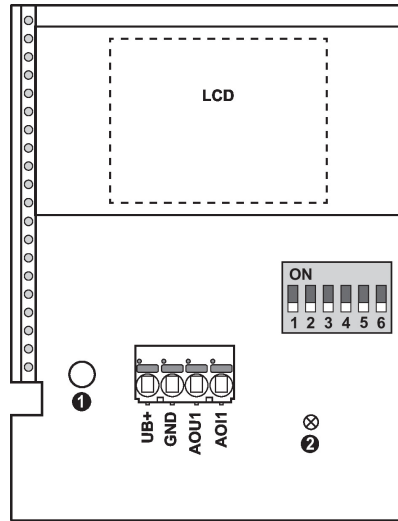

- Manual zero-point calibration ①
- Status LED ②
- Factory setting *
- Pressure unit P
- Response time T
- Output signal U

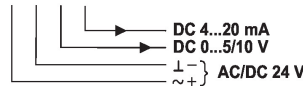
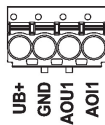

Setting	Range [Pa]	Range [inch WC]	Factory setting
S0	0...7000	0...28	✓
S1	0...5000	0...20	
S2	0...4000	0...16	
S3	0...3000	0...12	
S4	0...2500	0...10	
S5	0...2000	0...8	
S6	0...1500	0...6	
S7	0...1000	0...4	

Wiring note power supply AC

For the sensor to function properly, polarity must be observed with a DC supply as well as an AC supply.

If the AC supply is connected incorrectly, i.e. if the wires are reversed, this can lead to the destruction of the sensor.

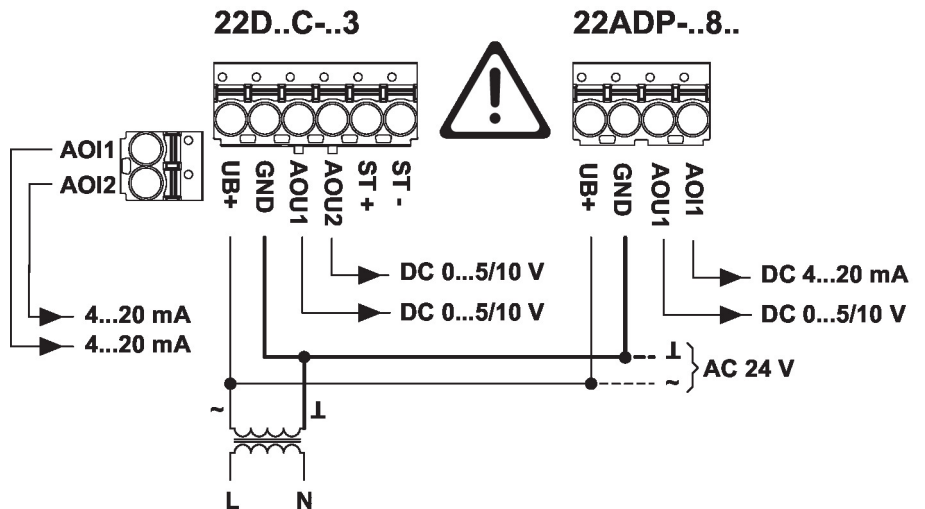

Dimensions

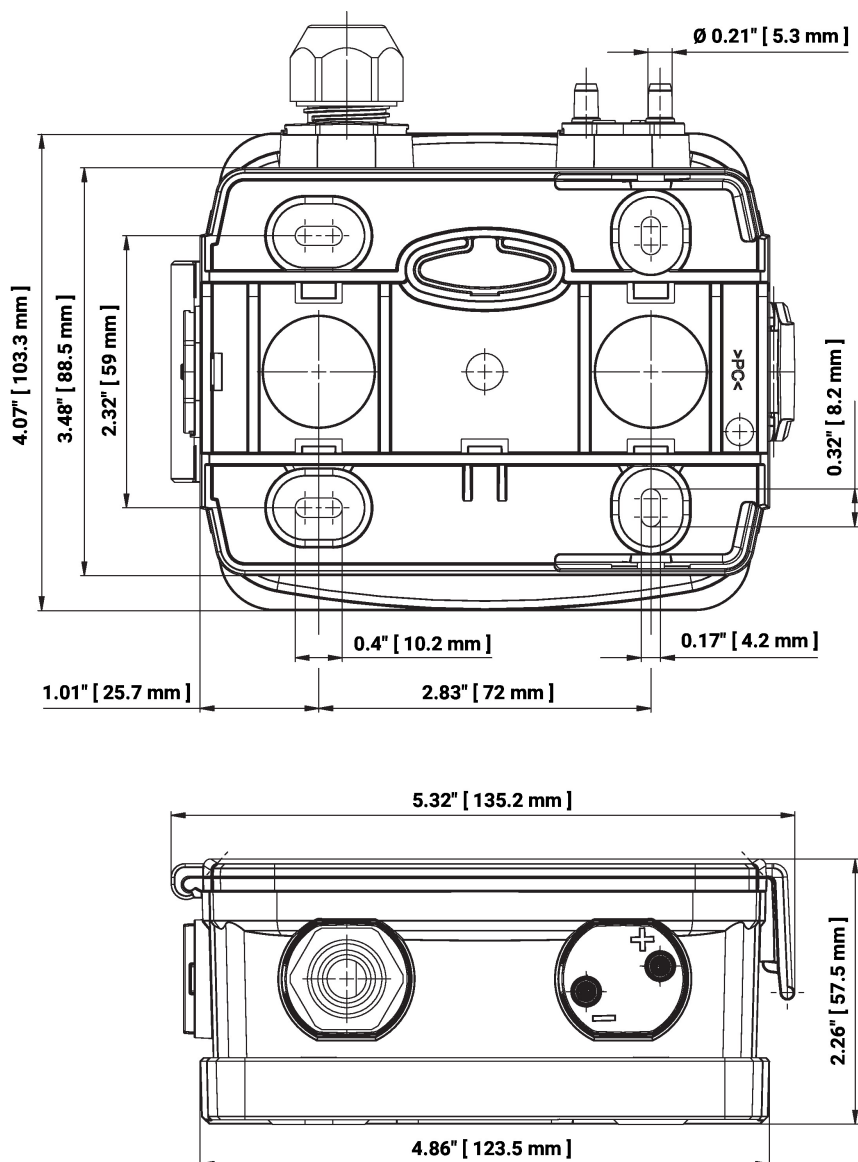

Further documentation

- Installation instructions