

SEZ91.6

Interface



Description	Interface between phase cut controllers and valves or actuators.
Features	<ul style="list-style-type: none"> • Input: 0 to 20 Vdc phase cut • Output: 0 to 10 Vdc • Two operating ranges, for magnetic valves and damper actuators • Inputs and outputs short-circuit-proof and protected against polarity reversal
Product Number	SEZ91.6

Warning/Caution Notations

WARNING:		Personal injury/loss of life may occur if a procedure is not performed as specified.
CAUTION:		Equipment damage may occur if the user does not follow a procedure as specified.

Application	The interface is used when operating 0 to 10 Vdc magnetic valves, Flowrite™ valves or OpenAir™ damper actuators in conjunction with controllers with a 0 to 20 Vdc phase cut output signal.
Function	<ul style="list-style-type: none"> • The SEZ91.6 interface is used in retrofit projects. • An operating voltage of 24 Vac is required for the interface. • All terminal connections are short-circuit-proof and protected against polarity reversal.

The SEZ91.6 is used as an interface between existing phase-cut controllers (e.g. KLIMO) and controlled devices with a standard 0 to 10 Vdc signal.

The proportional 0 to 20 Vdc phase-cut signal from the controller is converted into a 0 to 10 Vdc signal.

When used in conjunction with magnetic valves, the KLIMO controller has an operating range of 10 to 15 Vdc phase-cut. In conjunction with damper actuators, the operating range is 2 to 10 Vdc phase cut.

These two differing operating ranges are selected via the two separate input terminals "Y-Valve" and "Y-Damper actuator", eliminating the need to modify the controller parameters. The principle is the same for the position-controlled magnetic valves.

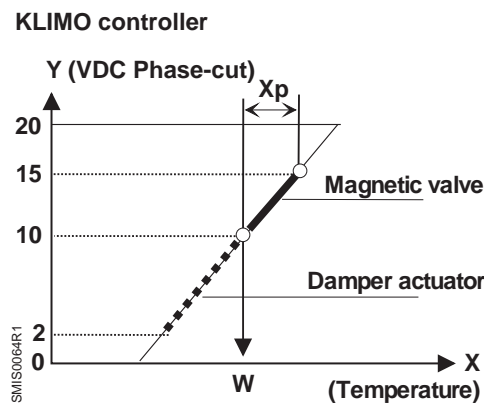

Figure 1. KLIMO Controller.

The effective operating range of the SEZ91.6 interface represents a slight adjustment in relation to the KLIMO controller data, but this does not affect the correct functioning of any of the devices involved.

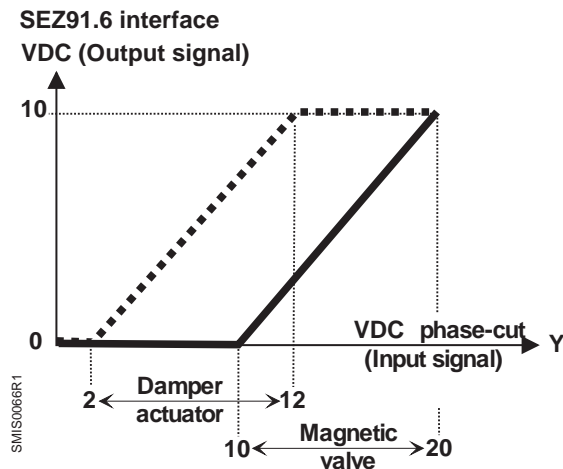

Figure 2. Effective Range.

Ordering When ordering, specify the quantity, product number and description.

- Mechanical Design**
- The plastic housing accommodates the printed circuit board and the terminal connections.
 - The housing is sealed with a plastic, shrink-wrapped sleeve.
 - The SEZ91.6 has a white label.
 - The two different operating ranges are selected by connection to the relevant input terminal.

- Mounting** Provided the interface is mounted in a dry environment, it can be located wherever there is sufficient space and in any orientation:
- In the control panel on DIN rails or in the trunking
 - Unit-mounted
 - In ceiling voids
 - In remote distributor boxes

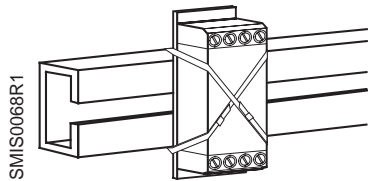

Figure 3. Mounting on DIN Rails.

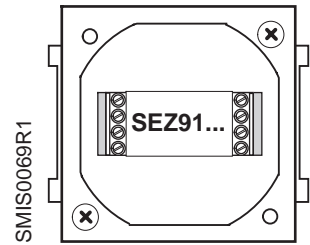

Figure 4. Mounting in Distributor Boxes.

Specifications	Operating voltage	24 Vac $\pm 20\%$, Class 2
	Frequency	50/60Hz
Supply Voltage (Output Side)	Power consumption, excluding field devices	0.5 VA
Inputs	0 to 20 Vdc phase cut for magnetic valves	
	Load impedance	2K ohm
	Maximum voltage (phase cut)	30 Vdc
	Operating range	10 to 20 Vdc phase cut
	0 to 20 Vdc phase cut for damper actuators	
	Load impedance	2K ohm
Maximum voltage (phase cut)	30 Vdc	
Operating range	2 to 12 Vdc phase cut	
Outputs	0 to 10 Vdc	
	Minimum load impedance	5K ohm
	Maximum output voltage	12 Vdc
Connections	Connection terminals	Screw terminals for maximum 2 x 14 AWG

**Specifications,
 Continued**

Weight/Dimensions

Weight (including packaging)	0.13 lb. (0.06 kg)
Dimensions (L x W x H)	2.24 x 0.87 x 0.71 inches (57 x 22 x 18 mm)

Ambient Conditions

Operation	
Temperature	32 to 122°F (0 to 50°C)
Humidity	Maximum 85% rh
Storage	
Temperature	-13 to 149°F (-25 to 65°C)
Humidity	Maximum 95% rh

Agency Approvals

Conforms to CE requirements

**Connection
 Terminals**

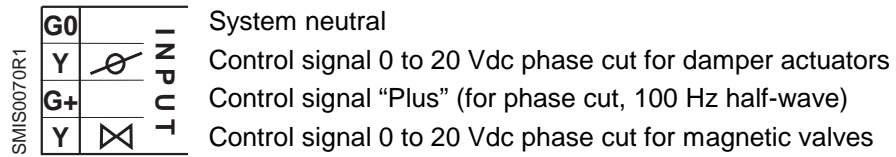

Figure 5. Input Side.

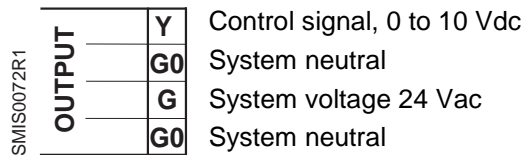

Figure 6. Output Side.

Wiring Diagrams

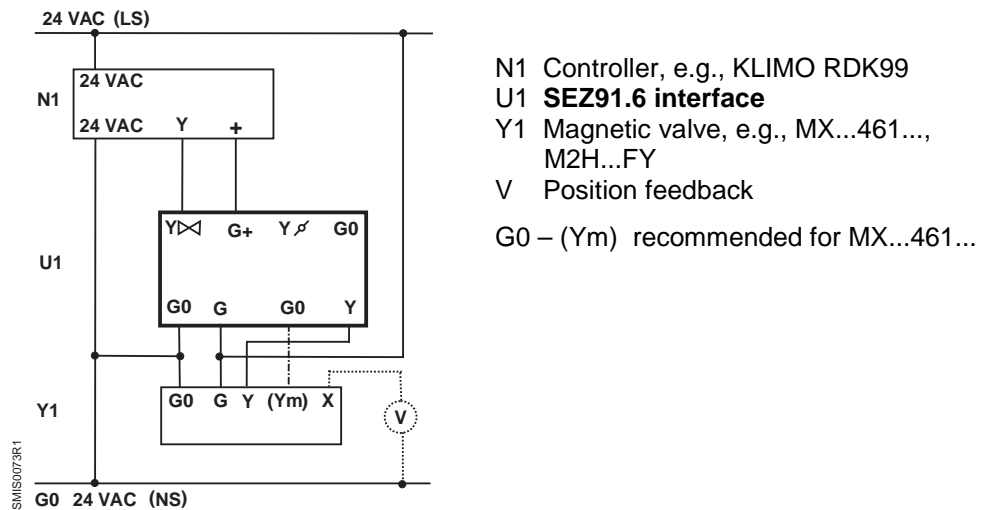

Figure 7. SEZ91.6 Interface with Magnetic Valves.

**Wiring Diagrams,
 Continued**

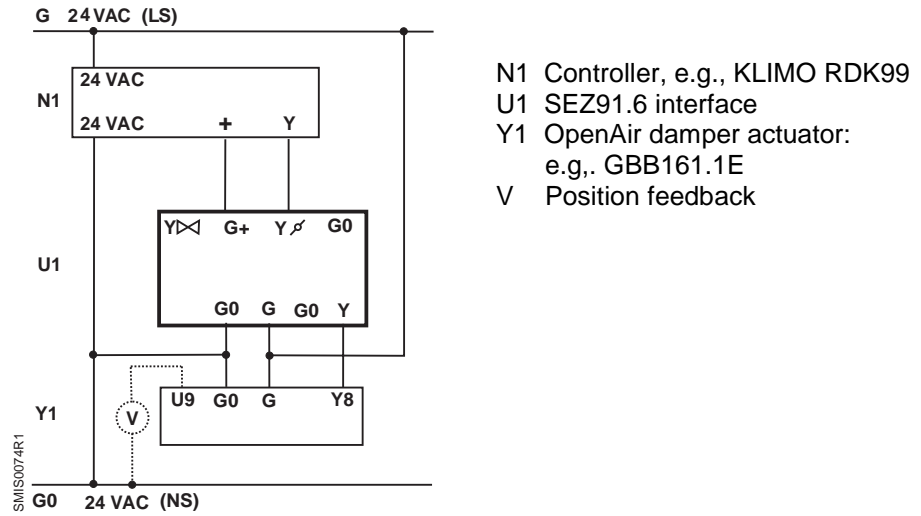

Figure 8. SEZ91.6 Interface with OpenAir Damper Actuators.

Dimensions

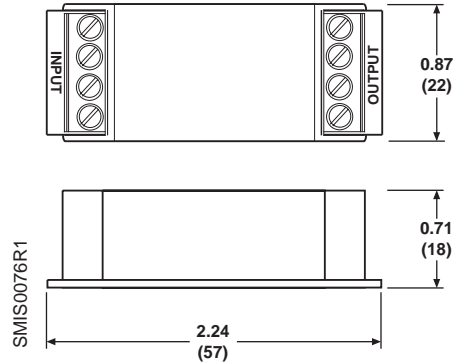

Figure 9. Dimensions in Inches (Millimeters).

Information in this publication is based on current specifications. The company reserves the right to make changes in specifications and models as design improvements are introduced. Flowrite and OpenAir are trademarks of Siemens Building Technologies, Inc. © 2000 Siemens Building Technologies, Inc.